

CRYSTAL UNIT	(SMD TYPE)	AUK-3225HT
AT-Cut Surface Mount Type Crystal Unit (AEC-Q200 Compliance Model)		

SPECIFICATIONS

Frequency Range	8 ~ 200.00	MHz
Operation Mode	Fundamental	
Frequency Tolerance@25°C	±10~±50	ppm
Frequency Stability	±50,±100,±150	ppm
ESR	60~100 max.	Ω
Load Capacitance	8	pF
Drive Level	0.1(20~70MHz),0.2(70+~200MHz)	mW
Operating Temperature	-40~+85, -40~+105, -40~+125	°C
Storage Temperature	-55~+125	°C

CASE DIMENSIONS (Unit:mm)

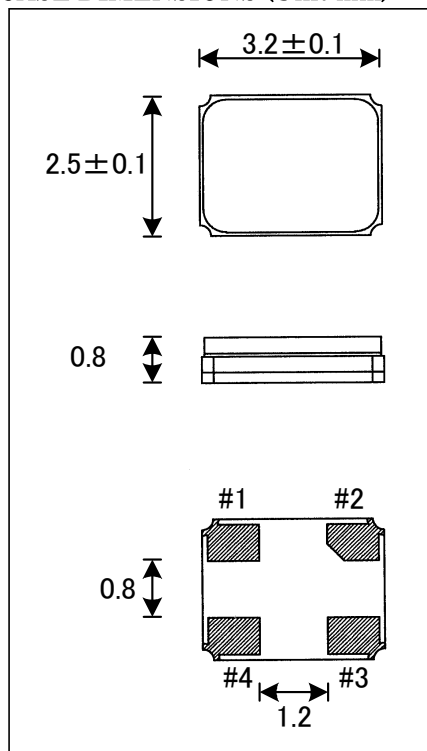

RECOMMENDED PADS

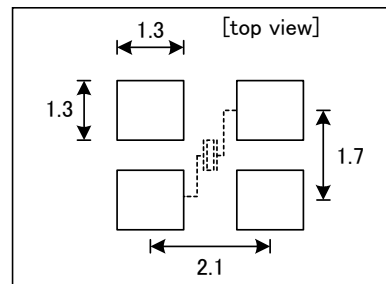

PIN CONNECTIONS

Pin#1	Crystal	Pin#3	Crystal
Pin#2	GND	Pin#4	GND